

## Table of Contents

Controller Components.....	2	Set Satellite Address .....	13
Selecting Control Options .....	3	Set Percent Adjust .....	13
Before Programming the Controller.....	4	Reviewing Program Information .....	14
About The Controller's Memory .....	4	Special Functions .....	14-15
Set Satellite Operating Mode .....	4	Self Test .....	14
Set Current Time and Day .....	5	Initialization .....	14
Set Station Run Times.....	5	Radio Calibration Test.....	15
Set Program Start Time(s) .....	6	Link Monitor .....	15
Set Active Day Watering Schedules .....	7	Troubleshooting .....	16
• Calendar Schedule.....	7	Lithium Battery Installation (Optional).....	16
• Interval Schedule .....	8	Manual Output Switch Operation .....	17
Set Program Repeat and Soak .....	9	Power Indicator Lamps .....	17
Program Operation Pause and Cancel .....	10	Program Data Reference Form.....	18
Manual Control Operations .....	10- 12		
Cycle Mode.....	10		
Syringe Mode .....	11		
Multi-Manual Mode .....	12		

## Power Specifications

Line Voltage: 115/230 V a.c. 50/60 Hz (switchable),  
130 VA (100W)  
Current Draw (no load): 0.21A @ 115 V a.c., 60 Hz, 0.10A  
@ 230V, 50 Hz  
Current Draw (maximum load): 0.90A @ 115 V a.c, 60 Hz,  
0.42A @ 230 V a.c, 50 Hz  
Secondary Voltage Output: 24 V a.c., 3.2A (77 VA)  
Maximum Load Per Station Output: 0.75A (18 VA)  
Maximum Load Per Pump/Master Valve Output:  
0.75A (18 VA)

## Hardware Features

Plastic or Painted Stainless Steel Cabinetry  
Front, Back and Top Locking Covers  
Removable Station Output and Common/Pump Modules  
Modular Station Output:  
16 to 64 stations in 8-station increments

## Fuses and Circuit Breakers

Power Supply:  
1.5A On/Off Switch/Circuit Breaker – Main Power Input  
3.2A Fuse (Slow-Blow) – Field Output  
4A Circuit Breaker – Control Functions  
Communication Modem (optional): 3/4A (Fast-Blow)  
Pump/Common & Communication Surge Protection  
Module (optional): 1/2A (Fast-Blow)

## Electromagnetic Compatibility

**Domestic:** This equipment has been tested and found to comply with the limits for a FCC Class A digital device, pursuant to part 15 of the FCC Rules. These limits are designed to provide reasonable protection against harmful interference when the equipment is operated in a commercial environment. The equipment generates, uses, and can radiate radio frequency energy and, if not installed and used in accordance with the instruction manual, may cause harmful interference to the radio communications. Operation in a residential area is likely to cause harmful interference in which case the user will be required to correct the interference at his own expense.

**International:** This is a CISPR 22 Class A product. In a domestic environment, this product may cause radio interference, in which case the user may be required to take adequate measures.

# CONTROLLER COMPONENTS

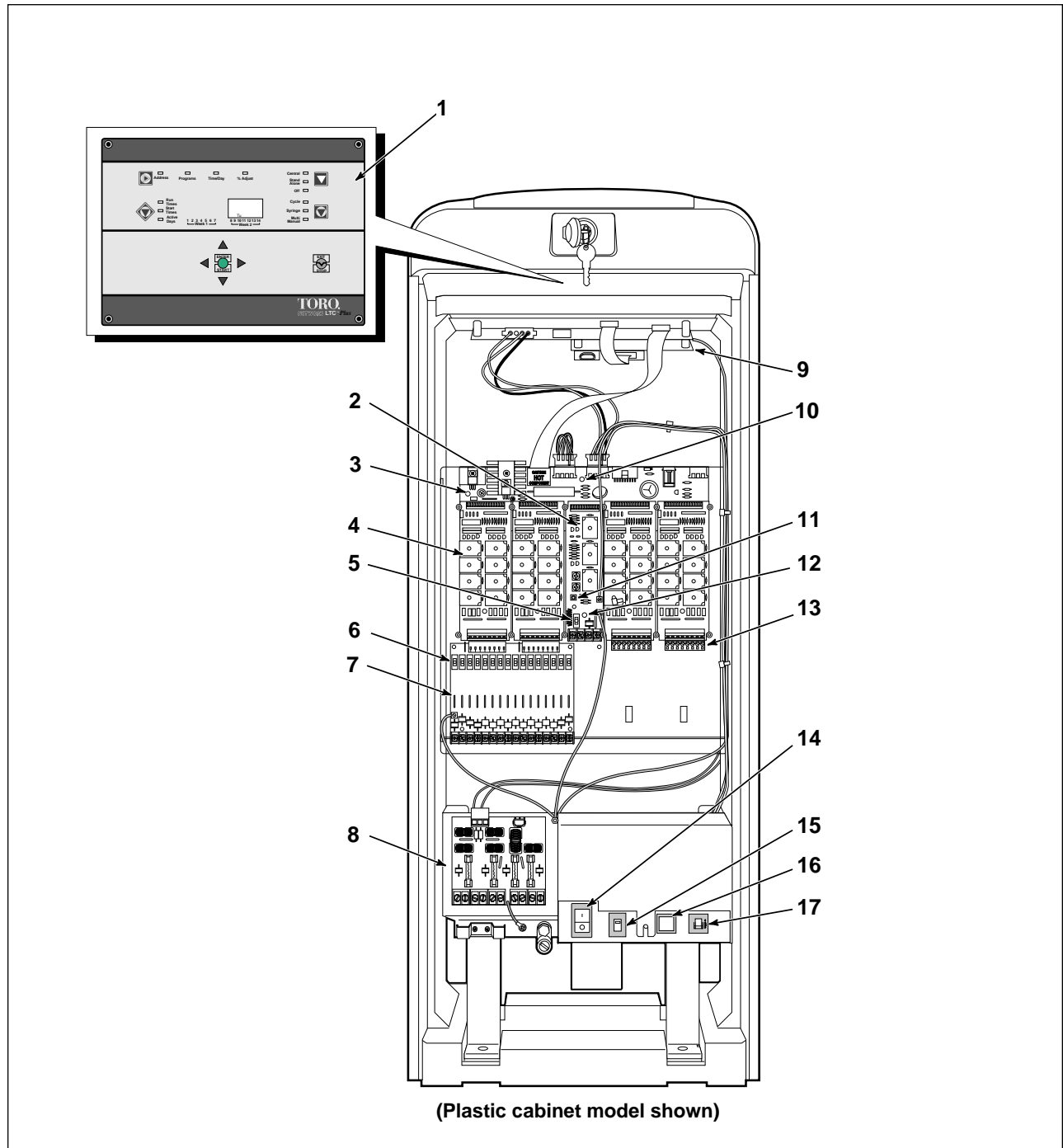

- |   |   |
|---|---|
| <ul style="list-style-type: none"> <li>1. Control Panel Assembly</li> <li>2. Pump/Common Output Module</li> <li>3. Power Indicator Lamp – (5V) Control Functions</li> <li>4. 8-Station Output Module</li> <li>5. Pump/Master Valve Control Switch</li> <li>6. Optional Station Output Control Switches</li> <li>7. Optional Station Output Surge Protection Module</li> <li>8. Optional Communication &amp; Pump/Common Surge Protection Module (Optional)</li> </ul> | <ul style="list-style-type: none"> <li>9. Optional Communications Modem</li> <li>10. Power Indicator Lamp – (28V) Station Output</li> <li>11. Field Common Engage Push-Button Switch</li> <li>12. Field Common Indicator Lamp</li> <li>13. Standard 8-Station Terminal Block</li> <li>14. Main Power On/Off Switch/1.5A Circuit Breaker</li> <li>15. Input Voltage Select Switch</li> <li>16. 3.2A Fuse – Station Output</li> <li>17. 4.0A Circuit Breaker – Control Functions</li> </ul> |
|---|---|

## Selecting Control Options

A set of eight DIP switches, located beneath the upper left corner of the control panel (as illustrated below) is provided for the selection of optional control characteristics. Power to the controller must be turned Off and the control panel removed from the cabinet in order to make switch position changes. When power is switched on, the controller will automatically reconfigure to the new switch settings (with the exception of switch 5). See \*Note below.

The controller is shipped from the factory in the following configuration:

**Switch 1 ON and Switch 2 ON** – Enables the controller to run **eight** programs concurrently.

- Option – Switch 1 OFF and Switch 2 ON – Enables the controller to run only **six** programs concurrently.
- Option – Switch 1 OFF and Switch 2 OFF – Enables the controller to run only **four** programs concurrently.
- Option – Switch 1 ON and Switch 2 OFF – Enables the controller to run only **two** programs concurrently.

**Switch 3 ON** – Time is displayed in a.m./p.m. format.

- Option – Switch 3 OFF – Time is displayed in 24-hour format (00:00–23:59)

**Switch 4 ON** – Pump output activates at the same time as station output.

- Option – Switch 4 OFF – Pump output starts 5 seconds prior to station output. (Enables pump to reach pressure prior to station operation.)

**Switch 5 ON** – Active day change occurs at midnight (12:00 a.m.[00:00])

- Option – Switch 5 OFF – Day change occurs at 6:00 a.m. (06:00)

**\*Note:** This change requires initialization to activate. See page 14 for initialization procedure.

**Switches 6, 7 & 8 are non-functional.**

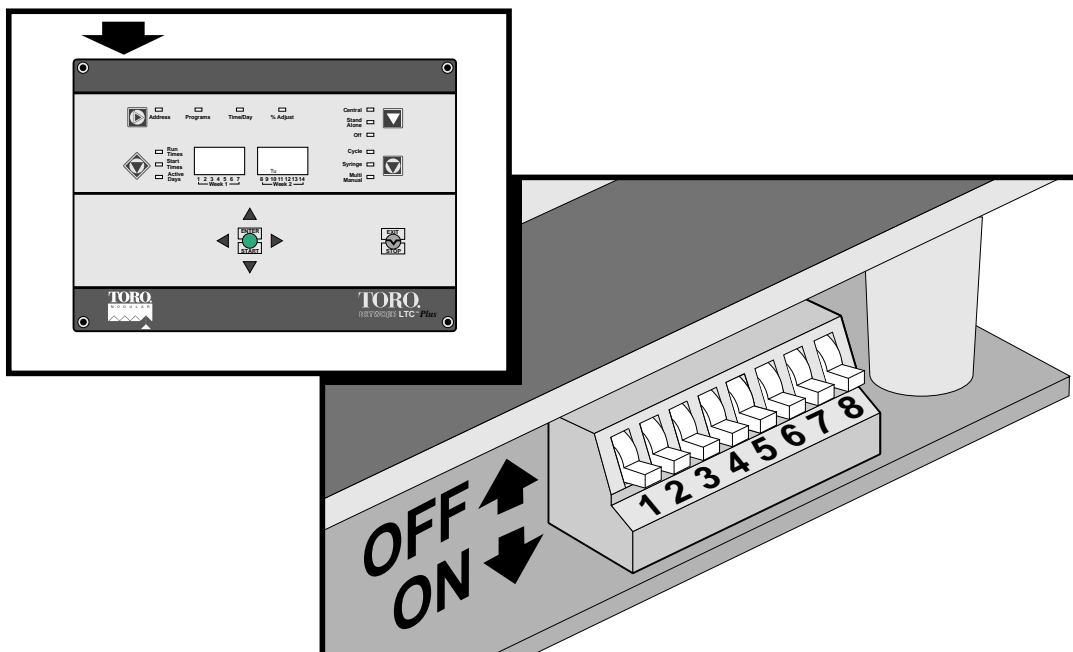

### To change the DIP switch positions:

1. Switch the power Off at controller power supply.
2. Remove the timing mechanism from the top of the pedestal cabinet. (The cables attached to the timing mechanism can remain connected for this procedure).
3. Locate the DIP switches mounted on top left corner of timing mechanism PCB.
4. Using a pen tip or small screwdriver, reset the DIP switches as required. (Do not use a pencil for this procedure. Loose graphite from the pencil can damage the switch mechanism).
5. Reinstall the timing mechanism and switch on the power.



## Before Programming the Controller...

Please note the following important information before programming the Network LTC Plus controller for the first time. Although the controller is quite easy to program, it does have some programming and operating characteristics which will be helpful to know before starting.

- \*If power is interrupted to the satellite within one minute of a programming entry, the controller memory will be initialized (erased) when power is restored.
- An audible “beep” tone occurs whenever a control panel key is pressed sufficiently. If the tone is not emitted, the key’s function will not be recognized.
- Programming can only be accomplished in the Central or Stand Alone control modes.
- The ◀ and ▶ (cursor keys) are used to navigate to the various program elements of the displays. When an element is selected, it begins flashing. Remember, a program element must be flashing before it can be changed.
- The ▲ and ▼ (scroll keys) are used to scroll forward or backward through the program element values. Holding either of these keys down for more than two consecutive seconds will initiate rapid scrolling.
- The  (Enter/Start key) must be pressed to enter a program change into memory.
- To exit a programming procedure, press the  (function select) key to select the Time/Day mode.
- During programming, the controller will automatically revert to Time/Day mode if a control panel key is not pressed for one minute.

## About the Controller’s Memory...

The controller utilizes a special “Super Cap” capacitor which stores enough power to maintain the current time/date and the currently active program information for approximately 30 minutes. The controller will be otherwise inactive during the power outage. In most circumstances, the user-defined program information is unaffected by a loss of power and is stored in memory for several years. (See \* above). When power is restored, any automatic programs operating prior to the power failure will resume from the point of interruption. Any manually started programs operating prior to the power failure will be canceled. Any automatic start times originating from the satellite or the central during the power failure will be ignored. In regions with frequent power interruptions, an optional lithium battery can be installed which will sustain real time and currently active program information for approximately 90 days of continuous duty. See “Battery Installation” on page 16 for more information.

## Set Satellite Operating Mode

Selecting one of three operating modes determines how the satellite will operate.

**Central** mode enables two-way communication between the satellite and the central controller. The satellite receives all operating commands (including the current time and day) from the central. No additional programming is required at the satellite. To operate in the Central mode, the satellite only requires an address which enables the central to locate it on the communication path. See “Set Satellite Address” on page 13.

**Stand Alone** mode enables the satellite controller to operate independently from the central. Any data downloaded from the central will be ignored by the satellite while in this mode. However, information regarding field status and manual satellite operations will be uploaded to the central. When operating as a stand-alone controller, the Network LTC Plus maintains 16 independent watering programs. Each program is given specific operating information consisting of: **Start Times** – when and how often the program will start, **Active Days** – the daily watering routine in either a 14-Day Calendar or 29-Day Interval schedule, and **Run Times** – the operating duration time of each station assigned to the program. During a program event, stations assigned to the program operate one at a time in numerical sequence.

**Off** mode terminates and prevents all automatic and manual controller operations.











If programming the satellite for stand-alone operation, we recommend that you first plan out your irrigation schedule using the Program Data Reference Form provided on the back cover. Make photocopies of the form for each program you intend to use. Organizing your program information in this way will provide a complete overview of your automatic irrigation schedule and simplify the programming task. After the forms have been filled in, keep them with the satellite for future reference.

1. Press the  key as needed to select the **Central**, **Stand Alone**, or **Off** indicator.

## Set Current Time and Day

Synchronizing the controller's clock with the current time and day is an important first step in the programming procedure. The timed events for all watering programs (when the satellite is in the Satellite Mode) are based on the settings you will make here.

Use the following procedure to set the current time and day:

1. Press  as needed to select **Time/Day** indicator.
2. Press  – The hour digit(s) will begin flashing.
3. Press  or  to increase or decrease hour digit(s). (Observe for correct a.m./p.m. time.)
4. Press  – Minute digits will begin flashing.
5. Press  or  to increase or decrease minute digits.
6. Press  – Day abbreviation will begin flashing.
7. Press  or  to select current day in either week of 14-day cycle.
8. Press  to store new information into controller memory.

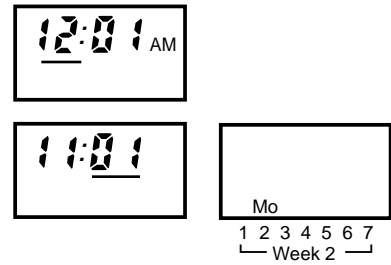

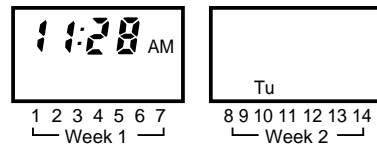

**Example:** Current Time 11:28 A.M.,  
Current Day Tuesday (10) Week 2.



## Set Station Run Time



Note the following Station Run Time characteristics:

- Run time can be set from one minute to eight hours and 59 minutes in one-minute increments.
- Each station can have a different assigned run time within each of 16 programs.



1. Press  to select the **Programs** indicator. The **Run Time** indicator will light. The program and station number will be shown in the left display, and the station run time will be shown in the right display.
2. Press  or  to select the desired program number (1–16).

**Note:** If the station run time has been adjusted to a value other than 100% using the % Adjust feature, the right display will alternate between the programmed run time and the adjusted run time. The **% Adjust** LED will light momentarily when the adjusted run time is displayed.





**Example Shown:** Program 1, station 2, run time 1 hour and 23 minutes.

3. Press  – The station number digits will begin flashing.
4. Press  or  to select the desired station number

**Note:** The controller will automatically determine the number of station modules installed and limit the display accordingly.

5. Press  to select the run time display. The hours digit will begin flashing.
6. Press  or  to select the desired hours of run time (0–8).

**Note:** If station operation is not desired during a particular program, enter **0:00** run time.

7. Press  – The minutes digits will begin flashing.
8. Press  or  to select desired minutes of run time (0–59).
9. Press  to enter the information.

10. Repeat steps 4–8 for each station as required.



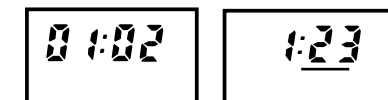
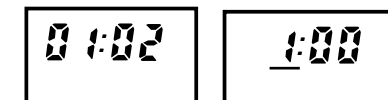
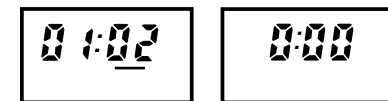
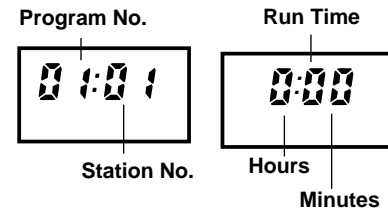







11. Press  – Repeat steps 2–11 for all programs.



## Set Program Start Time(s)





This procedure will determine when each program will start during a 24 hour period. Note the following characteristics:

- Each program can have from 1 to 12 start times.
- Start times can be set to the minute.
- Program operation can be prevented for any of the 12 start times by selecting OFF (no start time).
- When operating in the Stand Alone mode, any new start times downloaded from the central will be ignored.
- When operating in the Central mode, new start times downloaded from the central will be utilized.

1. Press  as needed to select the **Program** indicator.
2. Press  to select the **Start Time** indicator.
3. Press  or  to select the desired program number (1 – 16).
4. Press  – Start time 01 will begin flashing and current start time will be shown.
5. Press  or  to select desired start time number (1 – 12).
6. Press  – Hours digit(s) or "OFF" will begin flashing.
7. Press  or  to adjust hours digits up or down.  
(Observe for correct a.m./p.m. time.)

**Note:** If no start time is desired, select "OFF" – located between 11 p.m. and 12 a.m. (23:00 and 00:00). Skip steps 8 & 9 and continue at step 10.

**Example shown:** Program 1, start time 1 set to 2:30 a.m.

8. Press  – Minutes digits will begin flashing.
9. Press  or  to adjust minutes digits up or down.
10. Press  to enter the information.
11. Repeat steps 5 – 10 for all desired start times for this program.
12. Press  to select another program number.
13. Repeat steps 3 – 12 as required.

Program No.	Start Time No.	Current Start Time
1:01	1	OFF
1:01	2	OFF
1:01	3	2:00 AM
1:01	4	2:30 AM

## Set Active Day Watering Schedules











The active watering days for each program can be chosen using a Calendar schedule or an Interval schedule. The Calendar schedule enables active days to be selected within a 14-day (two week) cycle. The Interval Schedule enables active days to be selected by a specific interval, such as every day, every-other day, every-third day and so on – up to every twenty-ninth day.

Select the active watering days for each program using either a Calendar schedule (below) or an Interval schedule (on page 8).

### Note the following programming characteristics:

- Only one watering day schedule (Calendar or Interval) can be utilized for each program.
- To prevent automatic operation of any program, all days in a Calendar Schedule can be deleted or Interval Day can be set to Off.

### To Set a Calendar schedule:

1. Press  as needed to select the **Program** indicator.
2. Press  to select the **Active Days** indicator.
3. Press  or  until the desired program number (1 – 16) is flashing.
4. Press  – The schedule type will begin flashing.
5. Press  or  until **CA** (Calendar) is flashing.
6. Press  – The current Calendar schedule is displayed and Sunday (Su) of week 1 is flashing.
7. Choose to **select** or **delete** the indicated (flashing) day.
  - To **select**: Press  – The day stops flashing and remains displayed and the next day starts flashing.
  - To **delete**: Press  – The day disappears and next day starts flashing.
8. Repeat step 7 to set the 14-day watering schedule.

**Note:** To prevent automatic operation of the program, delete all 14 days or, as an alternate method, select Interval “Off”. See page 8 for this procedure.

9. Press  to enter the information into controller memory.
10. Repeat steps 3 – 9 for all programs requiring a Calendar schedule.

**Note:** If an Interval watering schedule is not required, programming for automatic operation is now complete. When an automatic program starts, the displays will alternate between the time/day and program status. If two or more programs are operating concurrently, the display will alternate to show status of each program.

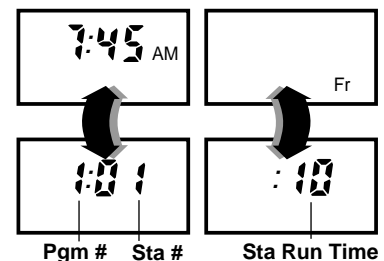
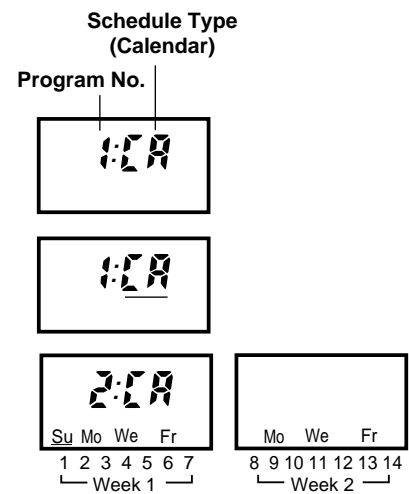

## Interval Schedule













Scheduling active days by Interval enables a program to operate on a specific routine such as, every other day, or every fourth day, without regard to actual calendar days.

The Interval schedule consists of two programmable numbers: The Interval Reference and the Interval Day. The Interval Reference number (01 – 29) determines how often an active watering day will occur. For example, entering 01 equals watering every day, 02 equals every other day and so on up to 29 for watering every 29th day. The Interval Day number (01 – 29 and Off) indicates when an active watering day will occur. The Interval Day number automatically decreases by one at the day changeover. An active watering day will occur when the Interval Day number is 01. As the day change occurs at the end of the active watering day, the Interval Day number will automatically update to display the number of days until the next active watering day.

During initial programming, the Interval Day number can be set at any point in the interval to establish the position of the interval within the week or month. For example, you may select a 6-day interval (watering every sixth day) but choose to start the interval tomorrow by entering an Interval Day number of 02. After one day has elapsed, the interval will begin and the day will be active. At the end of the active day, the Interval Day number will reset to 06, indicating six days until the next scheduled watering.

**Note:** The Interval Day number cannot be greater than the interval reference number. If attempted, the Interval Day number will automatically be reduced to equal the the Interval Reference number when the Enter/Start key is pressed.

### To set an Interval schedule:

1. Press  as needed to select the **Program** indicator.
2. Press  to select the **Active Days** indicator.
3. Press  or  until the desired program number (1 – 16) is flashing.
4. Press  – The schedule type will begin flashing.
5. Press  or  until **In** (Interval) is flashing
6. Press  –The Interval Reference digits will begin flashing.
7. Press  or  to select desired Interval Reference number (01 – 29).
8. Press  – Interval Day number will begin flashing.
9. Press  or  to select Interval Day (01 – 29).

**Example Shown:** Watering every third day (03), starting tomorrow (02).

**Note:** To prevent automatic operation of this program, select **Off** located between 00 and 29.

10. Press  to enter information into controller memory.

11. Repeat steps 3 – 10 for each program requiring an Interval schedule.

**Note:** Programming for automatic operation is now complete. When an automatic program starts, the displays will alternate between the time/day and program status. If two or more programs are operating concurrently, the display will alternate to show status of each program.

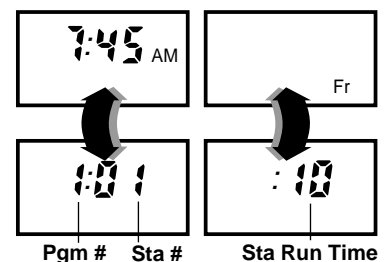
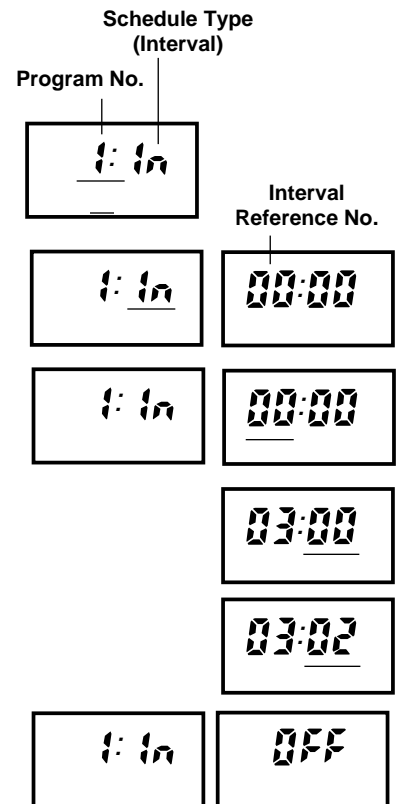



## Set Program Repeat and Soak

This is an optional programming feature which enables a program to repeat its operating cycle from 0 – 3 times (in addition to its initial cycle). A soak-in period from 0 – 59 minutes is placed between repeat cycles.

1. Press  as needed to select the **Program** indicator.
2. Press ▲ or ▼ until the desired program number (1 – 16) is flashing.
3. Press ► – 01 will begin flashing.
4. Press ▼ – The letter "r" (repeat) will begin flashing.
5. Press ► – The digit left of colon in the right side display will begin flashing.
6. Press ▲ or ▼ to display desired number of repeats (0 – 3).
7. Press ► – The digits right of colon will begin flashing.
8. Press ▲ or ▼ to select a soak time (0 – 59 minutes).

**Example Shown:** Program 1, 2 repeat cycles with a 10-minute soak time between cycles.

9. Press  to enter information into controller memory.
10. Press ◀ – The Program number will begin flashing.
11. Repeat steps 2 – 10 for all programs as required.

**Note:** During the soak period between watering cycles, the displays will alternate between Time/Day and Repeat/Soak status.

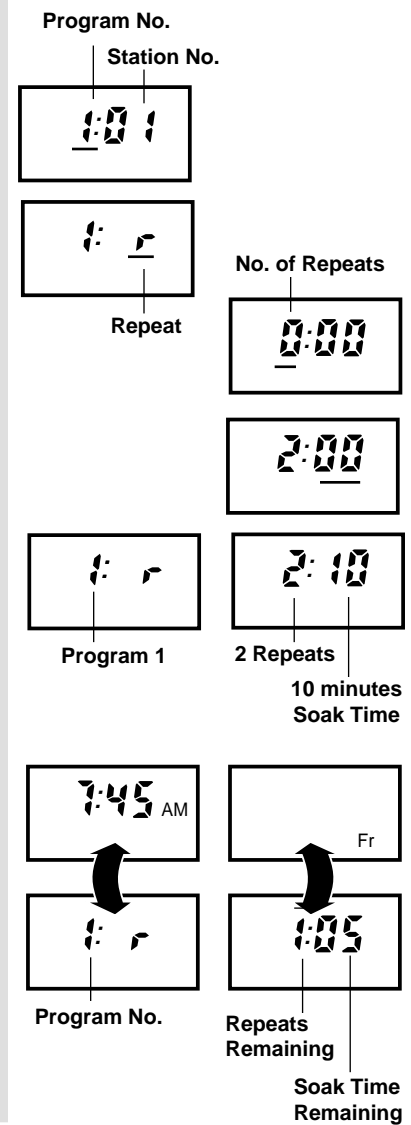

## Program Operation Pause and Cancel

An operating program can be paused or canceled at any time as needed. The pause feature temporarily suspends program operation for up to 10 minutes. When operation resumes, the program continues from the point of interruption without losing station run time. Use the cancel feature to terminate the program operation, returning the controller to the time and day mode.

**To pause program operation:** Press the  key while the program status is displayed. The right side display will show a letter **P** indicating the program is **Paused**.

**Note:** Program operation will resume automatically in 10 minutes if the Enter/Start key is **not** pressed.

**To resume program operation:** Press the  key.

**To cancel program operation:** Either press the  key **two** times, **or** press the  key to select **Off**, then press the key again as needed to select **Central** or **Stand Alone** mode.

## Manual Control Operations

Manual operations can be initiated at any time and can occur concurrently with automatically started watering operations. Three types of manual operations are available:





- **Cycle** mode to start complete or partial program cycle(s)
- **Syringe** mode to enable all stations in a program to be operated for a temporary run time from 1 – 30 minutes or 10 – 99%
- **Multi-Manual** mode to provide simultaneous operation of up to 6 stations.

### Cycle Mode

This mode enables you to start and run all or part of any automatic watering program. **Full Cycle** runs a complete cycle of any program selected. **Partial Cycle** starts the program cycle at any selected station, and runs only the stations (with programmed run time) which follow in the program cycle.







**Note:** During a manual operation, all programmed repeat and soak operations will be ignored.

#### ■ Full Cycle

1. Press  to select the **Cycle** indicator. The Program indicator will light and program 1 will be automatically selected.
2. Press  or  until the desired program number (1 – 16) is flashing.
3. Press  to start the program watering cycle. The displays will alternate between the Time/Day and program status displays.
4. To start additional programs, repeat steps 2 – 3.

**Note:** The maximum number of programs which can operate concurrently during manual operation is 4.



#### ■ Partial Cycle

1. Press  to select **Cycle** indicator. Program 1 will be automatically selected.
2. Press  or  until the desired program number (1 – 16) is flashing.
3. Press  – The first station number with a run time in the selected program will begin flashing.
4. Press  or  as required to select the station number to begin the partial cycle.
5. Press  to start the program watering cycle. The displays will alternate between the Time/Day and program status displays.





## Syringe Mode

The Syringe mode enables all stations with a programmed run time in a selected program to be operated for a short, temporary run time (syringe). The amount of run time for the syringe operation can be set from 1 – 30 minutes **or** by a percentage of programmed station run time from 10% – 99%.

### To syringe all stations from 1 – 30 minutes:

1. Press  to select **Syringe** indicator. Program 1 will be automatically selected .
2. Press  or  to select desired **Program** number (1 – 16).



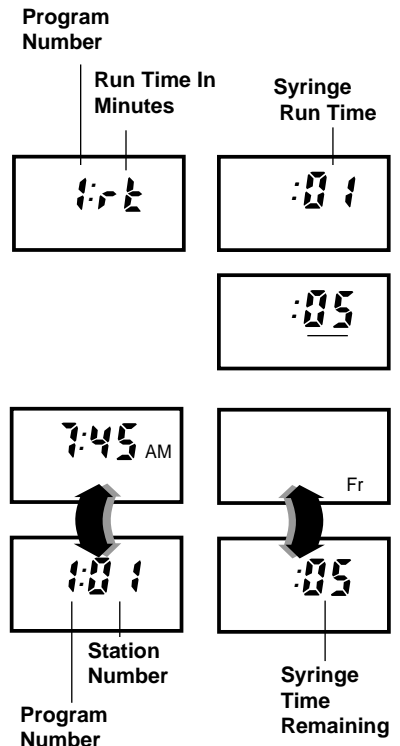

The Left display shows the program number and **rt** (run time in minutes). A 1-minute syringe time is automatically selected and shown in the right display. To increase the syringe run time, continue at step 3. If no increase is needed, continue at step 3.

3. Press  – The syringe time digits will begin flashing.
4. Press  or  to select a syringe time (02 – 30 minutes).
5. Press  to start the syringe cycle. The displays will alternate between the time/day and the program status.

**Note:** Only the stations with a programmed run time in the program selected will operate during the syringe operation.



### To syringe from 10% – 99% of station run time:

1. Repeat steps 1 and 2 above.
2. Press  The left display shows a % symbol. A 25% adjusted run time value is automatically selected and shown in the right display. To change the % value, continue at step 4; if no change is needed, continue at step 6.
3. Press  – Syringe % value (25%) will begin flashing.
4. Press  or  to adjust run time value from 10% – 99%.
5. Press  to start the syringe cycle. The displays will alternate between Time/Day and program status as shown above.



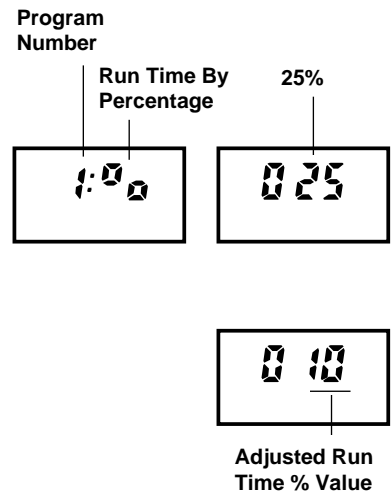



**Note:** When the station run time remaining becomes less than one minute, the display will show 00. The display will continue to show 00 while the remaining time of 59 seconds or less elapses.



## Multi-Manual Mode

Up to six selected stations can be operated at the same time using Multi-Manual mode. A temporary run time from 1 to 59 minutes is given to each station for this operation.

**Caution: Prior to Multi-Manual operation, ensure that combined current draw of all stations operating at the same time (including pump relay) does not exceed 3.2 Amps (holding).**

1. Press  to select the **Multi-Manual** indicator. The Program indicator will light and Station number **01** will be shown (flashing) in the left display. The right display will show **00** run time.
2. Press  or  as needed to select the desired station.
3. Press  – The Run Time digits will begin flashing.
4. Press  or  as needed to select desired Run Time (01 – 59)
5. Press  – Selected station will start.
6. Repeat steps **2 – 5** to start up to **five** additional Stations. If the same run time is desired, skip steps **3** and **4**.

**Note:** Any additional stations entered while six stations are in operation will be ignored.



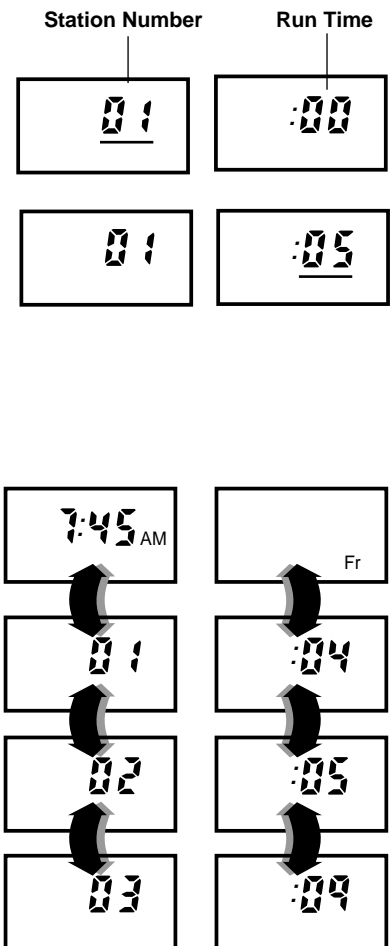





**Note:** After 1 minute has elapsed, the displays will begin alternating between the time/day and the program status, showing (in sequence) each operating station and its remaining run time.



## Set Satellite Address

The LTC satellite requires a unique address for identification by the central LCM within the network system. The address consists of a group number (1 – 50) and satellite number (1 – 500). A combination of up to 500 satellites may be defined. Satellites may only be assigned to one group. However, the same satellite number may be used for satellites in different groups. For example, satellite 001 in group 01 has a different address than satellite 001 in group 04. The satellite address is based on the combination of the group and satellite numbers.

Use the following procedure to assign the satellite address.

1. Press  to select **Address** indicator. The displays show the current group and satellite numbers. The default address is group 50, satellite 500.
2. Press  – Group number will begin flashing.
3. Press  or  to select desired group number (01 – 50).
4. Press  – Satellite number will begin flashing.
5. Press  or  to select desired satellite number (01 – 500).
6. Press  to enter the information.

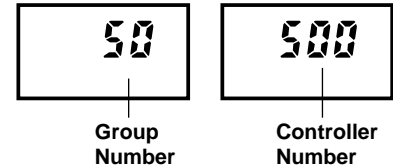







## Set Percent Adjust

This feature enables the run time of all stations assigned to a program to be adjusted by the same percentage up or down in 1% increments. Run time percent adjustments can be applied to individual programs and/or globally to all programs.

Note the following **Percent Adjust** characteristics:

- Adjustable from 10% to 250% (100% is neutral position).
- Adjusted station run time is displayed during program operation and while setting station run times. (See Note on page 5 regarding adjusted run time display.)
- % adjust values will be reset to 100% when operated in the **Central** control mode.
- Global adjust (**P0**) is applied to **all** programs **in addition to** individual program % adjust value.

**Example:** A 40 minute run time with a 50% Individual program adjust value and 50% Global adjust value equals 10 minutes adjusted run time ( $40 \times 50\% = 20 \times 50\% = 10$ ).

1. Press  to select **% Adjust** indicator. The displays show **P0** (Global adjust) and current % value. If global adjustment is desired, continue at step 3. If Global adjust is not desired, continue at step 2.
2. Press  or  as needed to select desired program number.
3. Press  – The percentage digits will begin flashing.
4. Press  or  to adjust the percentage up or down.





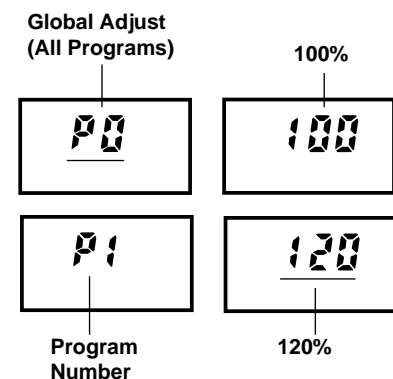

**Note:** For programs P1 – P16, an OFF position is provided between the 250% and 10% change point. Selecting OFF prevents the program from being affected by a global % adjustment and locks the program % adjust value at 100%.

5. Press  to enter the information.
6. Repeat steps 2 – 5 for all programs as required.



## Reviewing Program Information

To review the current operating information entered for any program, use the procedure below. If you need to make changes to any portion of a program or the Time/Day setting, refer to the appropriate procedure in the programming section of this manual.

1. Press  to select the **Program** number indicator.
2. Press  or  as needed to select the desired program number (1 – 16).
3. Press  to select the desired portion of program.
4. Press  or  or  as needed to step through program information.

## Special Functions

**Note:** Station/pump outputs will be momentarily cycled on and off several times during the self test and Initialization procedures. To prevent possible operation of irrigation valves and pump relay, remove the 3.2A fuse or disconnect the field common wire(s) until the test is completed.

### ■ Self Test

The Self Test enables the LTC satellite to automatically perform a diagnostic check of all functions, LED indicators, LCD elements, internal circuits and station/pump outputs.

#### To perform the self test:



1. Turn off power supply switch.
2. Press and hold  key down while switching power on. Continue holding key down for 5 seconds, then release.

During the first portion of the test, the displays will momentarily show the following information:

- Software version installed (i.e., version 1.0 = **1 0**)
- Number of stations installed (i.e., 16 stations = **16 STA**)
- Diagnostic code (i.e., **00 000**)
- Memory chip number (i.e., **EE1**)

**Note:** If the memory chip or timer chip is not functioning properly, **EE1 Err** or **CLK Err** will be displayed.

The next portion of the test cycles all LED indicators and LCD elements and turns the station/pump outputs on and off.

3. To end self test, press  and  keys simultaneously. Current time will be displayed (flashing). Press the  key to stabilize display.



### ■ Initialization

**Note:** Performing an initialization permanently erases all user defined program information from the satellite memory (except current time and day).

#### To perform an initialization:

1. Turn off power supply switch.
2. Press and hold  key down while switching power on. Continue holding key down for 5 seconds, then release.



**Note:** The satellite will perform the same operation as the Self Test (as detailed above), however during the process all user defined information stored in the memory will be erased.

3. To end initialization process, press  and  keys simultaneously. Current time will be displayed (flashing). Press the  key to stabilize display.

## Radio Calibration Test

The radio calibration test enables the LTC to generate three different radio test patterns for use in radio network communications setup. If a radio is not connected, no indication is seen on the TM. The test patterns can be monitored by connecting an oscilloscope or headphones to the modem 2-wire connector.

### To Perform Radio Calibration Test:

1. Turn off power to controller at power supply switch.
2. Press and hold ◀ key while switching on the power. Continue holding down the key for 5 seconds. The left display will show **CAL**.
3. **Wait 30 seconds**
  - Press ◀ – A 1200 Hz test pattern will be generated for 30 seconds.
  - Press ▶ – A 2200 Hz test pattern will be generated for 30 seconds.
  - Press  – An alternating 1200/2200 Hz test pattern will be generated for 30 seconds.
4. Press  to exit Radio Calibration Test mode.

## Link Monitor

Link Monitor enables any satellite communicating with the central to review the communications link status of all satellites within the network. During Link Monitor operation, the central continuously polls the network satellites in numerical sequence and rapidly displays the addresses accompanied by an audible “beep”. If a satellite does not respond to the central during the polling process, the satellite address remains displayed for two seconds and is accompanied by two additional beeps. After all satellites have been polled, the last satellite address in numerical sequence remains displayed for ten seconds. The polling sequence is repeated continuously until the Link Monitor is exited by pressing the Exit/Stop key.

1. Press and hold down the ▶ key for five seconds to activate Link Monitor mode.

**Note:** If this satellite is not connected to the network or if the LCM is not polling, **00 000** will be displayed.

2. Press the  key to exit the Link Monitor mode.

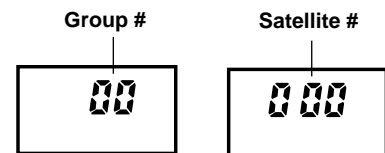

## Troubleshooting

If you experience a controller problem, check the programming for a possible programming error and the list of problems and solutions listed below. If the problem continues, contact your local Toro distributor for assistance.

	<p><b>WARNING</b></p> <p><b>TO AVOID ELECTRICAL SHOCK HAZARD, ASSURE POWER SOURCE IS OFF BEFORE ATTEMPTING ANY CONTROLLER REPAIR. ALL REPAIRS SHOULD BE PERFORMED BY A QUALIFIED TECHNICIAN.</b></p>
---	--

Problem	Probable Cause	Remedy
<ul style="list-style-type: none"> <li>■ Controller inactive — no display</li> </ul>	<ol style="list-style-type: none"> <li>1. 4A control circuit breaker tripped.</li> <li>2. Power supply On/Off switch in Off (O) position.</li> </ol>	<ol style="list-style-type: none"> <li>1. Check output module switches. Set ALL switches to Auto or Off. Reset 4A circuit breaker.</li> <li>2. Position switch in On (–) position.</li> </ol>
<ul style="list-style-type: none"> <li>■ Controller on — valve(s) not operating</li> </ul>	<ol style="list-style-type: none"> <li>1. Improper valve connection(s).</li> <li>2. Station output module switch in Off position.</li> <li>3. 3.2A fuse blown.</li> </ol>	<ol style="list-style-type: none"> <li>1. Check connections.</li> <li>2. Set output module switch to Auto position.</li> <li>3. Replace 3.2A fuse</li> </ol>
<ul style="list-style-type: none"> <li>■ Pump does not operate</li> </ul>	<ol style="list-style-type: none"> <li>1. Pump output module control switch in Off position.</li> <li>2. Pump component malfunction.</li> <li>3. Improper pump connection(s).</li> </ol>	<ol style="list-style-type: none"> <li>1. Set control switch to Auto position</li> <li>2. Repair or replace faulty pump components.</li> <li>3. Check connections.</li> </ol>
<ul style="list-style-type: none"> <li>■ Limited number of programs can be operated at a time</li> </ul>	<ol style="list-style-type: none"> <li>1. DIP switch #1 and #2 position.</li> </ol>	<ol style="list-style-type: none"> <li>1. Check position of DIP switch #1 &amp; #2. See page 3.</li> </ol>
<ul style="list-style-type: none"> <li>■ a.m. or p.m. designation does not appear with clock time</li> </ul>	<ol style="list-style-type: none"> <li>1. DIP switch #3 in Off position — time displayed in 24-hour format.</li> </ol>	<ol style="list-style-type: none"> <li>1. Set DIP switch #3 to On position. See page 3.</li> </ol>

## Lithium Battery installation (optional)

An optional 3.9V lithium battery (P/N 363-2200) can be installed to sustain the controllers clock time and the currently active program information for approximately 90 days with no additional power applied.

	<p><b>WARNING</b></p> <p><b>DANGER OF EXPLOSION IF BATTERY IS INSTALLED INCORRECTLY. REPLACE ONLY WITH THE SAME OR EQUIVALENT TYPE OF BATTERY. ALWAYS DISPOSE OF USED BATTERIES ACCORDING TO THE BATTERY MANUFACTURER'S INSTRUCTIONS.</b></p>
---	---

### Procedure

1. Turn off power to controller at power supply switch.
2. Remove phillips screws from corners of control panel and carefully lift panel up.
3. Turn control panel over, resting it face down on pedestal. Connector cables can remain attached to PCB for this procedure.
4. Remove five phillips screws from back of control panel PCB and separate PCB from faceplate assembly.
5. Locate battery pin sockets located on front side of PCB as shown at right. Insert battery carefully to avoid bending contact pins. The pins are unevenly spaced allowing the battery to be installed easily in one direction only. **Do not force battery pins into sockets.** See Warning above.
6. Reassemble control panel assembly and reinstall into pedestal.
7. Restore power to controller at power supply switch.

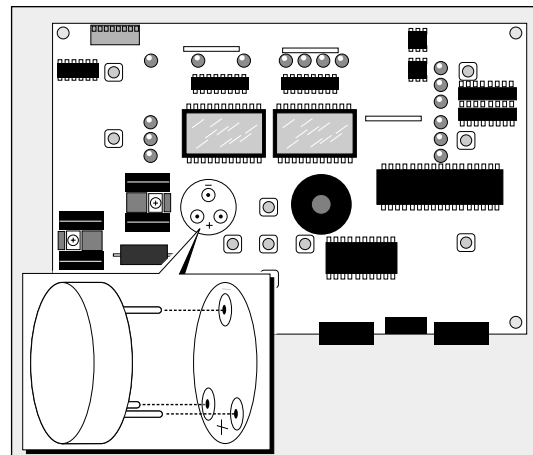



## Manual Output Switch Operation

A 3-position switch is provided on the Pump/Com module for additional control of the pump relay circuit. In addition, the optional station terminal modules with optional control switches have one switch for each station output.

The three switch positions control the circuits as follows:

**On** – Manually activates the circuit. The pump or station will remain on until the switch is moved to the Auto or Off position.

**Off** – Switches the circuit off, preventing pump or station operation from the satellite.

**Auto** – The circuit is automatically activated by the controller during automatic or manual watering operation.

As an added lightning protection measure, the field common circuit is normally open when the controller is inactive. Therefore, to use the field output control switches for manual operation, the common circuit must be engaged first. Press the Field Common Engage push button switch to activate the circuit. The Field Common Indicator Lamp will turn on when the circuit is active. The common circuit will automatically disconnect upon completion of an automatic or manually activated watering operation initiated through the timing mechanism. The circuit can also be disconnected by momentarily switching the power supply off.

**Caution:** To prevent damage to the 3.2A field output circuit fuse, do not exceed 3.2A load when manually activating multiple field outputs.

## Power Indicator Lamps

Two indicator lamps, as shown in the illustration at right, are provided to verify the presence of power to the control and field output circuits. In normal operating conditions, both lamps will be On. If both lamps are Off, no power is present. Ensure the power supply/circuit breaker switch is On. Also check the main power source circuit breaker and any additional power disconnection devices in the fixed wiring. If the left indicator lamp is Off, the 4A circuit breaker is open and must be reset. If the right indicator lamp is off, the 3.2A field output fuse is blown.



**WARNING**  
IF FUSE REPLACEMENT IS REQUIRED,  
REPLACE WITH A FUSE OF THE SAME  
TYPE AND AMPERAGE RATING. FAILURE  
TO COMPLY CAN RESULT IN SERIOUS  
INJURY AND/OR EQUIPMENT DAMAGE  
DUE TO FIRE HAZARD.

## Removing and Installing 8-Station Modules

1. Switch power supply Off
2. Remove single screw from module.
3. Pull module outward from top connector then upward from bottom connector (if installed).
4. Install module in reverse order.

**Note:** When adding modules, utilize the first available open position from left to right, front to back. Do not leave open spaces between modules.

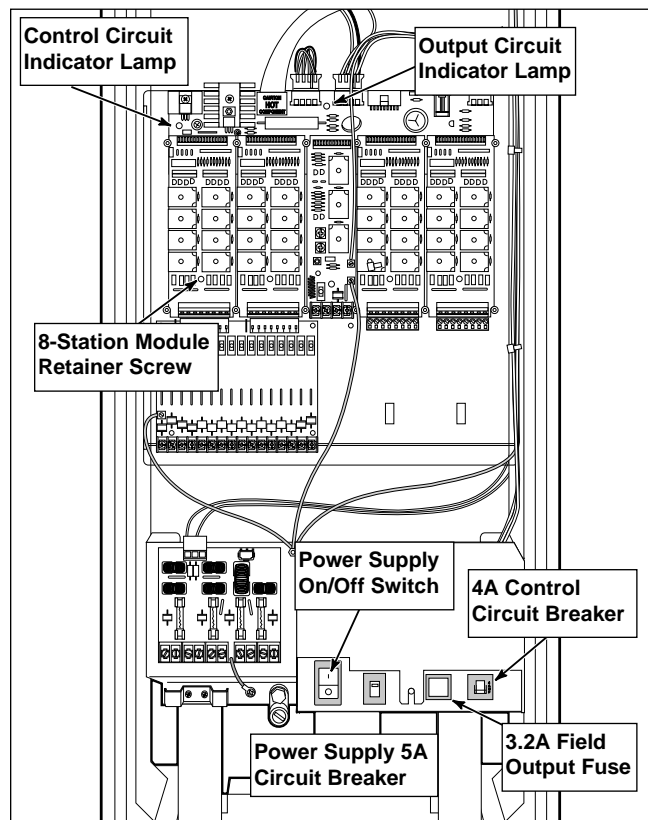
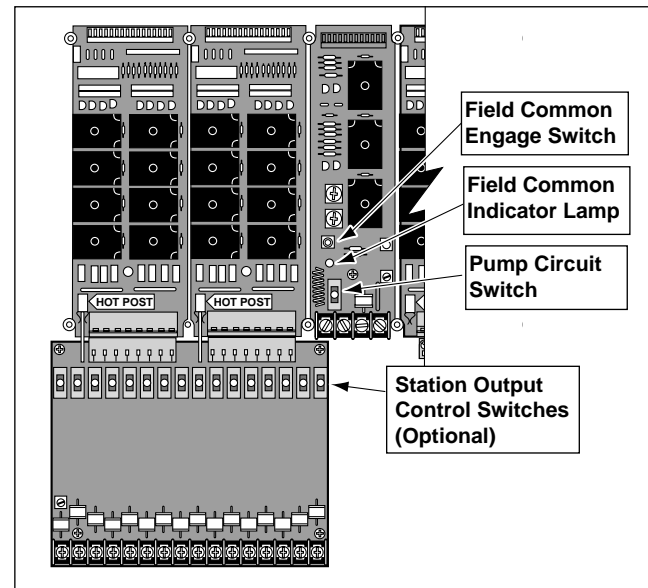

# Program Data Reference Form

Program Number \_\_\_\_\_ Date \_\_\_\_\_

## Station Location

1 _____	17 _____	33 _____	49 _____
2 _____	18 _____	34 _____	50 _____
3 _____	19 _____	35 _____	51 _____
4 _____	20 _____	36 _____	52 _____
5 _____	21 _____	37 _____	53 _____
6 _____	22 _____	38 _____	54 _____
7 _____	23 _____	39 _____	55 _____
8 _____	24 _____	40 _____	56 _____
9 _____	25 _____	41 _____	57 _____
10 _____	26 _____	42 _____	58 _____
11 _____	27 _____	43 _____	59 _____
12 _____	28 _____	44 _____	60 _____
13 _____	29 _____	45 _____	61 _____
14 _____	30 _____	46 _____	62 _____
15 _____	31 _____	47 _____	63 _____
16 _____	32 _____	48 _____	64 _____

## Station Run Time (1 minute to 8 hours 59 minutes)

Sta. 1 ___ hrs. ___ min.	Sta. 17 ___ hrs. ___ min.	Sta. 33 ___ hrs. ___ min.	Sta. 49 ___ hrs. ___ min.
Sta. 2 ___ hrs. ___ min.	Sta. 18 ___ hrs. ___ min.	Sta. 34 ___ hrs. ___ min.	Sta. 50 ___ hrs. ___ min.
Sta. 3 ___ hrs. ___ min.	Sta. 19 ___ hrs. ___ min.	Sta. 35 ___ hrs. ___ min.	Sta. 51 ___ hrs. ___ min.
Sta. 4 ___ hrs. ___ min.	Sta. 20 ___ hrs. ___ min.	Sta. 36 ___ hrs. ___ min.	Sta. 52 ___ hrs. ___ min.
Sta. 5 ___ hrs. ___ min.	Sta. 21 ___ hrs. ___ min.	Sta. 37 ___ hrs. ___ min.	Sta. 53 ___ hrs. ___ min.
Sta. 6 ___ hrs. ___ min.	Sta. 22 ___ hrs. ___ min.	Sta. 38 ___ hrs. ___ min.	Sta. 54 ___ hrs. ___ min.
Sta. 7 ___ hrs. ___ min.	Sta. 23 ___ hrs. ___ min.	Sta. 39 ___ hrs. ___ min.	Sta. 55 ___ hrs. ___ min.
Sta. 8 ___ hrs. ___ min.	Sta. 24 ___ hrs. ___ min.	Sta. 40 ___ hrs. ___ min.	Sta. 56 ___ hrs. ___ min.
Sta. 9 ___ hrs. ___ min.	Sta. 25 ___ hrs. ___ min.	Sta. 41 ___ hrs. ___ min.	Sta. 57 ___ hrs. ___ min.
Sta. 10 ___ hrs. ___ min.	Sta. 26 ___ hrs. ___ min.	Sta. 42 ___ hrs. ___ min.	Sta. 58 ___ hrs. ___ min.
Sta. 11 ___ hrs. ___ min.	Sta. 27 ___ hrs. ___ min.	Sta. 43 ___ hrs. ___ min.	Sta. 59 ___ hrs. ___ min.
Sta. 12 ___ hrs. ___ min.	Sta. 28 ___ hrs. ___ min.	Sta. 44 ___ hrs. ___ min.	Sta. 60 ___ hrs. ___ min.
Sta. 13 ___ hrs. ___ min.	Sta. 29 ___ hrs. ___ min.	Sta. 45 ___ hrs. ___ min.	Sta. 61 ___ hrs. ___ min.
Sta. 14 ___ hrs. ___ min.	Sta. 30 ___ hrs. ___ min.	Sta. 46 ___ hrs. ___ min.	Sta. 62 ___ hrs. ___ min.
Sta. 15 ___ hrs. ___ min.	Sta. 31 ___ hrs. ___ min.	Sta. 47 ___ hrs. ___ min.	Sta. 63 ___ hrs. ___ min.
Sta. 16 ___ hrs. ___ min.	Sta. 32 ___ hrs. ___ min.	Sta. 48 ___ hrs. ___ min.	Sta. 64 ___ hrs. ___ min.

## Start Times:

1. _____ am / pm	4. _____ am / pm	7. _____ am / pm	10. _____ am / pm
2. _____ am / pm	5. _____ am / pm	8. _____ am / pm	11. _____ am / pm
3. _____ am / pm	6. _____ am / pm	9. _____ am / pm	12. _____ am / pm

## Program Repeat:

0    1    2    3   Soak Time (0-59 minutes) \_\_\_\_\_ Minutes

## Active Day Schedule:

<b>Calendar</b>	Week 1	<input type="checkbox"/> Su-1	<input type="checkbox"/> Mo-2	<input type="checkbox"/> Tu-3	<input type="checkbox"/> We-4	<input type="checkbox"/> Th-5	<input type="checkbox"/> Fr-6	<input type="checkbox"/> Sa-7		
	Week 2	<input type="checkbox"/> Su-8	<input type="checkbox"/> Mo-9	<input type="checkbox"/> Tu-10	<input type="checkbox"/> We-11	<input type="checkbox"/> Th-12	<input type="checkbox"/> Fr-13	<input type="checkbox"/> Sa-14		
<b>Interval</b>	<input type="checkbox"/> 01	<input type="checkbox"/> 04	<input type="checkbox"/> 07	<input type="checkbox"/> 10	<input type="checkbox"/> 13	<input type="checkbox"/> 16	<input type="checkbox"/> 19	<input type="checkbox"/> 22	<input type="checkbox"/> 25	<input type="checkbox"/> 28
	<input type="checkbox"/> 02	<input type="checkbox"/> 05	<input type="checkbox"/> 08	<input type="checkbox"/> 11	<input type="checkbox"/> 14	<input type="checkbox"/> 17	<input type="checkbox"/> 20	<input type="checkbox"/> 23	<input type="checkbox"/> 26	<input type="checkbox"/> 29
	<input type="checkbox"/> 03	<input type="checkbox"/> 06	<input type="checkbox"/> 09	<input type="checkbox"/> 12	<input type="checkbox"/> 15	<input type="checkbox"/> 18	<input type="checkbox"/> 21	<input type="checkbox"/> 24	<input type="checkbox"/> 27	

© 1998 The Toro Company  
Irrigation Division



# Network LTC™ *Plus* Series Satellite

## U s e r ' s   G u i d e

